

WARING COMMERCIAL®

Europe Power Pack

WSBPPCE - 036313

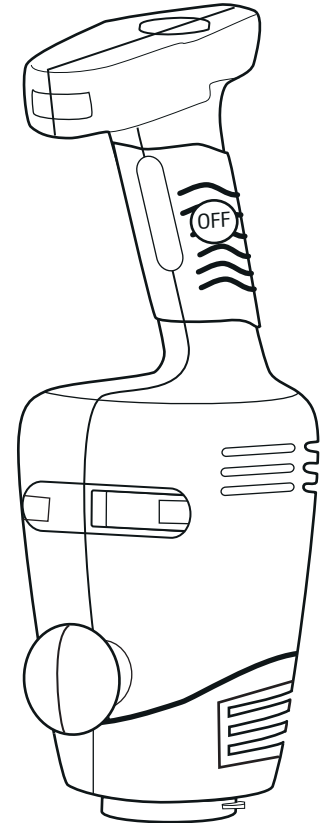
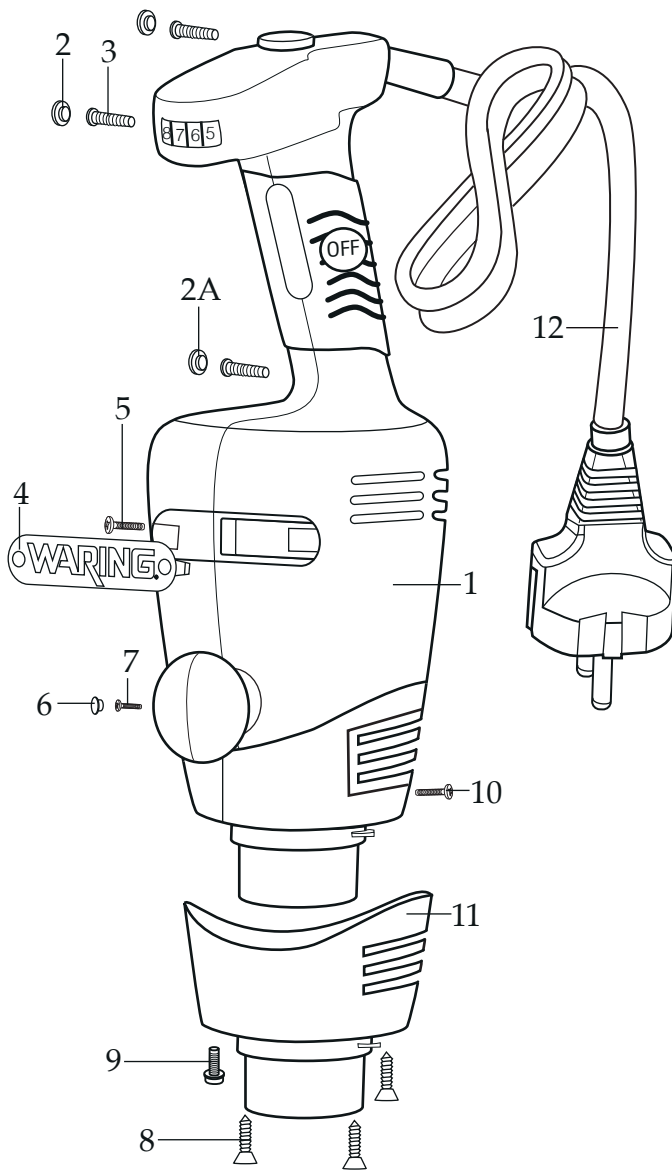

037435
Housing Kit

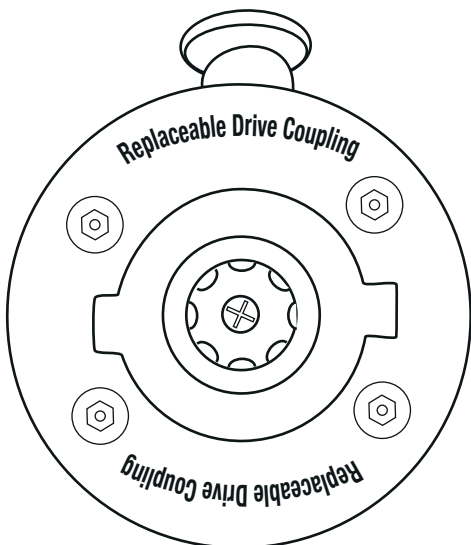

To use the 503357 kit the bottom of your Power Pack must look like this.

503357 Kit Parts Included *(part changed in 2007)*



Power Pack Coupling Tool

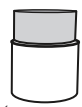

(current)



(old style)



Shaft Coupling Tool





Catalog/Model

WSBPPCE



032650 - Speed Control Knob

Waring Factory Service Center
314 Ella T. Grasso Ave.
Torrington, CT 06790
Tele. 1-800-269-6640

WARING
COMMERCIAL

Fax 860-496-9017
www.waringcommercialproducts.com

**WSBPPCE Internal and
Optional Components**

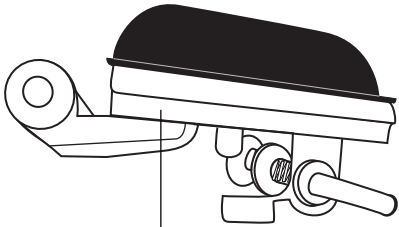

038173 - Trigger Assembly



503281
PCB Board Assembly

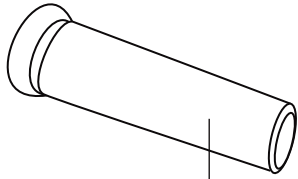

037922 - Cord Bushing



038174 - Button Assembly

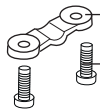

033666 - Cord Clamp



033654 - Screws (2 required)

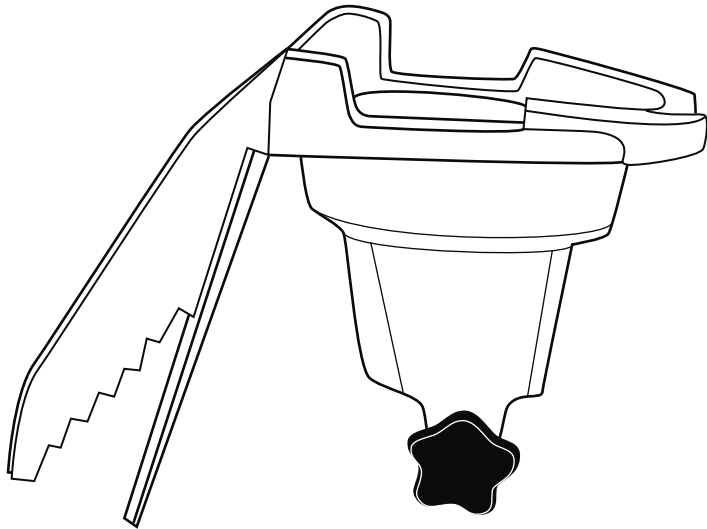
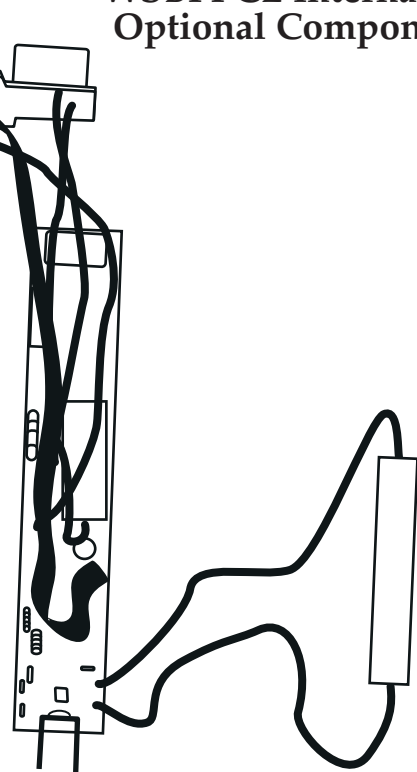

033016 (WSBBC)
Bowl Clamp

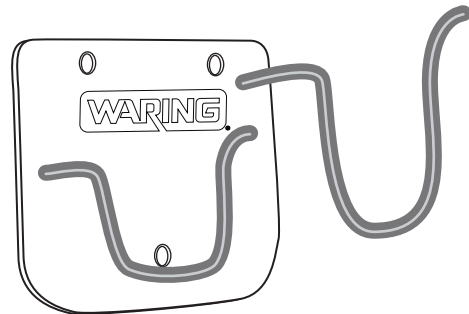

033017 (WSB01)
Wall Hanger

Catalog/Model

WSBPPCE



Illustration#	Part#	Description
1	036313	WSBPPCE Power Pack
2	029839	Hole Plug (2 required)
2A	029905	Hole Plug
3	029840	Screw (3 required)
4	029841	Name Plate Panel
5	029842	Screw
6	029843	Hole Plug
7	029844	Screw
8	029845	Screw (3 required)
9	029846	Screw
10	029844	Screw
11	030440	Housing Cover
12	035896	Cord